



Power Take Offs

Relation 1 : 1,35

Ref. TF4038AMP

ZF

S6-36 ; 6S-850 ; 6S-700
REINFORCED

To apply with Gear Pumps or with Piston Pumps

Main Dimensions

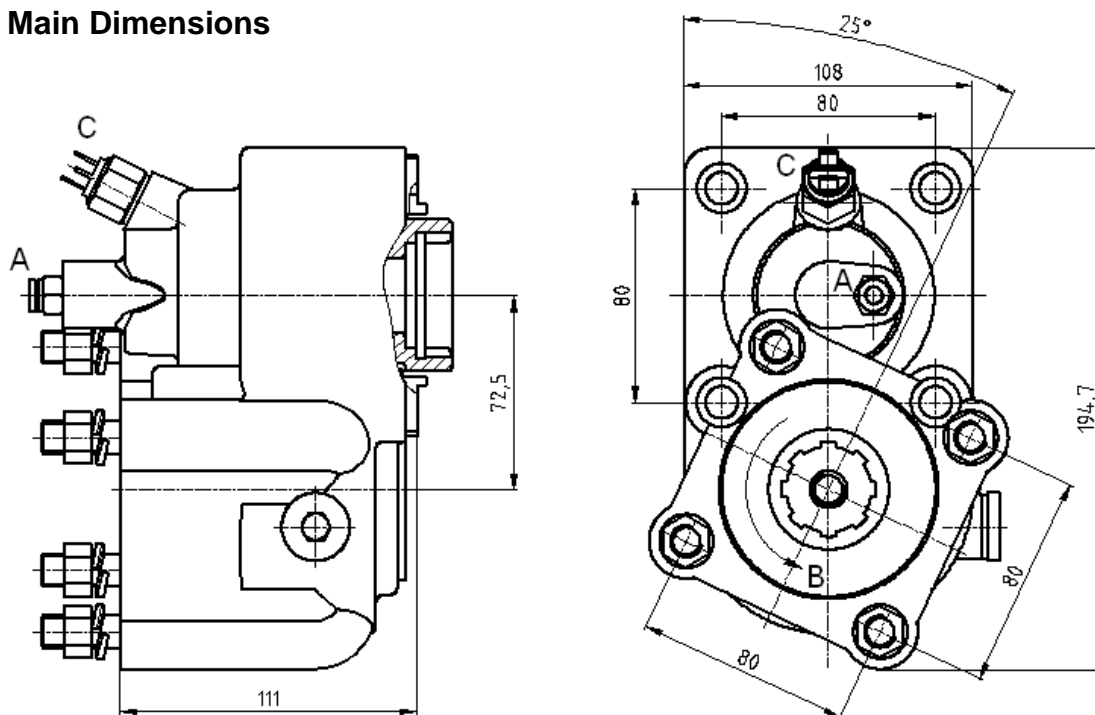

A – Air connection

B – Sense of rotation

C – Option: Electric sensor with mechanical driving Ref. TF4038AMPS or TF4038AMPC

(Dimensions in mm)

Main Data

Continuous Torque (Nm)	450
Intermittent Torque (Nm)	550
Power (at 1000 rpm)	62 cv / 46 kW
Mounting Position	Rear
Pump Rotation	Right Hand
Weight (kg)	11
PTO internal ratio	1:1,35
Indicative ratio from motor to PTO's output	
6-S-850 / 6.72-0.79	- 1 : 0.716
/ 6.93-0.80	- 1 : 0.689
/ 7.43-1.00	- 1 : 0.648
/ 8.97-1.00	- 1 : 0.541
S6-36 / 6.06	- 1 : 0.787
/ 6.93 - 0.80	- 1 : 0.589
/ 7.43 - 1.00	- 1 : 0.648
/ 8.97 - 1.00	- 1 : 0.541
/ 7.43 - 0.85+GV36	High: 1 : 0.756 Normal: 1 : 0.644
/ 8.97 - 0.83+GV36	High: 1 : 0.644 Normal: 1 : 0.531